

Models: PD3000/PD6000 Series

Customer Displays

2 by 20 character display

USER MANUAL



NOTICE

The manufacturer of the POS pole display makes no representations or warranties, either expressed or implied, by or with respect to anything in this manual, and shall not be liable for any implied warranties of fitness for a particular purpose or for any indirect, special or consequential damages. Information in this document is subject to change without notice and does not represent a commitment on the part of the manufacturer.

FCC NOTICE

This equipment generates, uses, and can radiate radio frequency energy and if not installed and used in accordance with this manual, may cause interference to radio communications. It has been tested and found to comply with the limits for a Class A digital device pursuant to Subpart J of Part 15 of FCC Rules, which are designed to provide reasonable protection against interference when operated in a commercial environment. Operation of this equipment in a residential area is likely to cause interference in which case the user at his own expense will be required to take whatever measures may be required to correct the interference.

LOGIC CONTROLS, INC.

355 Denton Avenue
New Hyde Park, NY 11040

TEL: (516) 248-0400

FAX: (516) 248-0443

Email: lci@logiccontrols.com

<http://www.logiccontrols.com>

TABLE OF CONTENTS

FEATURES.....	1
MODEL IDENTIFICATION.....	2
CARTON CONTENTS	2
INSTALLATION.....	3
FUNCTIONAL TEST	5
INTERFACE CONNECTION.....	8
SOFTWARE COMMANDS	10
HARDWARE CONFIGURATION	12
DISPLAY CHARACTER CODES	13
GENERAL SPECIFICATIONS	14

FEATURES

The PD3000/PD6000 family of pole displays offers a wide range of high quality features and models to choice from. Listed below are the features incorporated into each pole display. Not all features are available in all models. The model identification chart will assist you in selecting the model best suited to your needs.

The PD3000 family has the industry standard 5mm high vacuum fluorescent 5x7 pixel display. The PD6000 family has a pixel height of 11.25mm, one of the largest vacuum fluorescent displays on the market today.

Features - All Models

- Bright green fluorescent display
- Supports high speed serial protocol: up to 19,200 baud rate, 1 stop bit
- Automatic message scrolling
- Two line display with 20 characters per line
- Matched optical lens for better viewing contrast
- Ergonomic design
- Direct RS232C or parallel interface
- Long life and trouble free operation
- Five adjustable viewing angles
- Simple installation
- Available with 120V or 220V Power Adapters

Features - Model dependent

- Emulation of other popular command sets
- User definable character
- Parallel pass-thru
- True RS232C pass-thru
- Real time clock
- One time message scrolling
- Ability to disable attention code
- Ability to change attention code

MODEL IDENTIFICATION

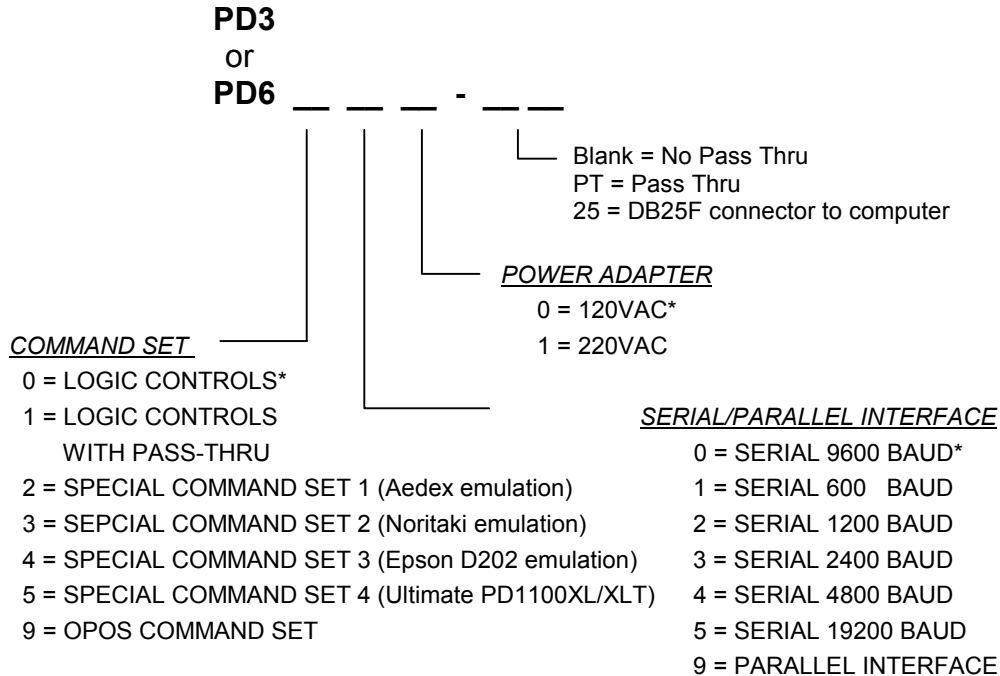

* Default Values
** Call for description of Command Sets

CARTON CONTENTS

1. Pole display, pre-assembled.
2. Interface cable, comes with a DB9F connector (to computer) and a DIN6F connector (to pole display) as standard equipment. Optional DB25F connector (to computer) is available.
Note: This cable is only supplied with standard serial pole displays with no pass-thru function.
3. Transformer adapter 120VAC to 6.0VAC (optional 220VAC).
4. Metal base plate with mounting hardware.
5. Quick Installation Guide.

INSTALLATION

Your PD3000/PD6000 family of pole displays has been pre-assembled to make the installation as simple as possible.

Serial Interface Non-pass-thru Models Installation

1. Mount the pole display to the metal base plate using the mounting hardware provided.
2. The pole display can be used in a freestanding mode or attached to the counter using the remaining mounting hardware.
3. Connect the round DIN6M connector from the pole display to the round DIN6F connector of the interface cable.
4. Connect the DB9F connector to the computer's serial COM1 or COM2 port.
5. Connect the female phone jack of the power adapter to the male phone jack of the interface cable.
6. Plug the power adapter into a 120VAC outlet.
7. A start up text message (LOGIC CONTROLS POS COMPONENTS) will be present for a short time. When this message disappears the cursor will be displayed at the left-most digit of the top row.

Parallel Interface Non-pass-thru Models Installation

1. Mount the pole display to the metal base plate using the mounting hardware provided.
2. The pole display can be used in a freestanding mode or attached to the counter using the remaining mounting hardware.
3. Connect the DB25M connector to the computer's parallel printer port (LPT1).
4. Connect the female phone jack of the power adapter to the male phone jack of the pole display cable.
5. Plug the power adapter into a 120VAC outlet.
6. A start up text message (LOGIC CONTROLS POS COMPONENTS) will be present for a short time. When this message disappears the cursor will be displayed at the left-most digit of the top row.

Serial Interface Pass-thru Models Installation

- 1 Mount the pole display to the metal base plate using the mounting hardware provided.
- 2 The pole display can be used in a freestanding mode or attached to the counter using the remaining mounting hardware.
- 3 Connect the DB25M connector to the peripheral device or a serial pass-thru terminator (optional accessory). Turn on power of the peripheral device.
- 4 Connect the DB9F connector to the computer's serial COM1 or COM2 port.
- 5 Connect the female phone jack of the power adapter to the male phone jack of the pole display cable.
- 6 Plug the power adapter into a 120VAC outlet.
- 7 A start up text message (LOGIC CONTROLS POS COMPONENTS) will be present for a short time. When this message disappears the cursor will be displayed at the left-most digit of the top row.

Parallel Interface Pass-thru Models Installation

- 1 Mount the pole display to the metal base plate using the mounting hardware provided.
- 2 The pole display can be used in a freestanding mode or attached to the counter using the remaining mounting hardware.
- 3 Connect the DB25F connector to the peripheral device or parallel pass-thru terminator (optional accessory). Turn on power of the peripheral device.
- 4 Connect the DB25M connector to the computer's parallel printer port (LPT1).
- 5 Connect the female phone jack of the power adapter to the male phone jack at the DB25M/DB25F connector.
- 6 Plug the power adapter into a 120VAC outlet.
- 7 A start up text message (LOGIC CONTROLS POS COMPONENTS) will be present for a short time. When this message disappears the cursor will be displayed at the left-most digit of the top row.

FUNCTIONAL TEST

The following test sequence will verify that your pole display is working properly. Before you start this procedure, you must install the pole display correctly as outlined under the INSTALLATION section. The functional test should be done under *MSDOS command prompt* by booting up the computer in DOS mode, or shell out to DOS prompt (in window95/98/ME) or COMMAND prompt (in windows NT/2000).

NOTE: The actual key entries in the text below are enclosed within quotation marks (" "). Do **not** type the quotation marks as part of your entries.

Serial Interface Pole Displays Functional Test

This test procedure assumes the pole display is connected to COM1 of the computer. If COM2 is being used, type COM2 where COM1 is called out.

Close all opened application programs that use the same COM port before going into DOS command prompt. Enter the following command lines to open the COM port for communication with the pole display:

Type "MODE COM1 96,N,8,1" and press the ENTER key.
Type "TYPE CON>COM1" and press the ENTER key.

PD3000, PD3300, PD3400, PD3500, PD3900, PD6000, PD6300, PD6400, PD6500 and PD6900

1. Type "ABCDEFGH" and press ENTER key. The display will show "ABCDEFGH" on the first line.
2. To end the test press Ctrl-C (hold down Ctrl and press C).

PD3200 and PD6200

1. Type "!#1ABCDEFGH" and press ENTER key. The display will show "ABCDEFGH" on the first line.
2. To end the test press Ctrl-C (hold down Ctrl and press C).

***PD3100-PT, PD3300-PT, PD3400-PT, PD3500-PT, PD6100-PT,
PD6300-PT, PD6400-PT and PD6500-PT***

1. Type "ABCDEFGH" and press ENTER key. The display will show "ABCDEFGH" on the first line.
2. Type "^APASSTHRU" (^A represents Ctrl-A) and press ENTER key. The data will be passed through to the peripheral (e.g. a printer). These characters are not shown on the display.
3. Type "!#^BNUMBER12345", then press ENTER key. The display will show "NUMBER12345" on the first line.
4. To end the test press Ctrl-C (hold down Ctrl and press C).

PD3200-PT and PD6200-PT

1. Type "!#1ABCEDFGH" and press ENTER key. The display will show "ABCDEFGH" on the first line.
2. Type "PASSTHRU" and press ENTER key. The data will be passed through to the peripheral (e.g. a printer). These characters are not shown on the display.
3. Type "!#1NUMBER12345", then press ENTER key. The display will show "NUMBER12345" on the first line.
4. To end the test press Ctrl-C (hold down Ctrl and press C).

Parallel Interface Pole Displays Functional Test

This procedure assumes the pole display is connected to the LPT1 port of the computer. If parallel port LPT2 is being used, type LPT2 where LPT1 is called out.

***PD3090, PD3390, PD3490, PD3590, PD3990, PD6090, PD6390,
PD6490, PD6590 and PD6990***

1. Type "ECHO ABCDEFGH>LPT1" and press ENTER key. The display will show "ABCDEFGH" on the first line.

PD3290 and PD6290

1. Type "ECHO !#1ABCEDFGH>LPT1" and press ENTER key. The display will show "ABCDEFGH" on the first line.

***PD3190-PT, PD3390-PT, PD3490-PT, PD3590-PT, PD6190-PT,
PD6390-PT, PD6490-PT and PD6590-PT***

1. Type "ECHO ABCDEFGH>LPT1" and press ENTER key. The display will show "ABCDEFGH" on the first line.
2. Type "ECHO ^APASSTHRU>LPT1" (^A represents Ctrl-A) and press ENTER key. The data will be passed through to the peripheral (e.g. a printer). These characters are not shown on the display.
3. Type "ECHO !#^BNUMBER12345>LPT1", then press ENTER key. The display will show "NUMBER12345" on the first line.

PD3290-PT and PD6290-PT

1. Type "ECHO !#1ABCDEFGH>LPT1" and press ENTER key. The display will show "ABCDEFGH" on the first line.
3. Type "ECHO PASSTHRU>LPT1" and press ENTER key. The data will be passed through to the peripheral (e.g. a printer). These characters are not shown on the display.
3. Type "ECHO !#1NUMBER12345>LPT1", then press ENTER key. The display will show "NUMBER12345" on the first line.

For further testing of OPOS displays (PD3900, PD3990, PD6900 and PD6990), follow the instructions in the readme.doc file after software installation.

INTERFACE CONNECTION

Serial Interface Connector Configuration

The pin out configuration for the standard serial pole display is a DB9F connector. It plugs directly into the serial port of the computer.

1. DCD (tied to pins 4&6)
2. NC
3. TXD from PC
4. DTR (tied to pins 1&6)
5. Ground
6. DSR (tied to pins 1&4)
7. RTS (tied to pin 8)
8. CTS (tied to pin 7)
9. NC

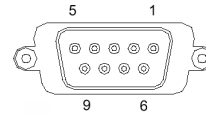

DB9F (to computer)

For pass-through models, the display cable comes with two connectors. The DB9F is to be connected to the computer while the DB25M is for connection to the peripheral.

1. DCD (tied to pins 4&6)
2. NC
3. TXD from PC
4. DTR (tied to pins 1&6)
5. Ground
6. DSR (tied to pins 1&4)
7. RTS (tied to pin 8)
8. CTS (tied to pin 7)
9. NC

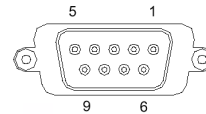

DB9F (to computer)

1. NC
2. TXD to peripheral
3. RXD from peripheral
4. RTS
5. CTS (tied to pin 20)
6. NC
7. Ground
8. NC
- 9-19. NC
20. DTR (tied to pin 5)
- 21-25. NC

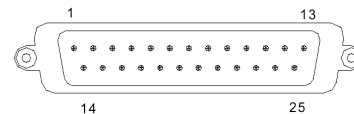

DB25M (to peripheral)

Parallel Interface Connector Configuration

All standard parallel pole displays will have a DB25 male connector. It is connected to the printer port of the computer.

- 1. –Strobe
- 2. Data 0
- 3. Data 1
- 4. Data 2
- 5. Data 3
- 6. Data 4
- 7. Data 5
- 8. Data 6
- 9. Data 7
- 10. –Ack
- 11. Busy
- 12-17 NC
- 18-25 Ground

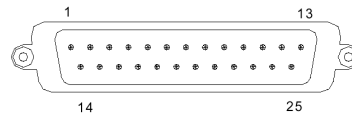

DB25M (to computer)

For pass-through models, the display cable comes with a dual DB25M/F connector. The DB25M is to be connected to the computer while the DB25F is for connection to the peripheral.

- 1. –Strobe
- 2. Data 0
- 3. Data 1
- 4. Data 2
- 5. Data 3
- 6. Data 4
- 7. Data 5
- 8. Data 6
- 9. Data 7
- 10. –Ack
- 11. Busy
- 12. Paper End
- 13. Select
- 14. -Auto Feed
- 15. -Error
- 16. -Initialize Printer
- 17. -Select In
- 18-25. Ground

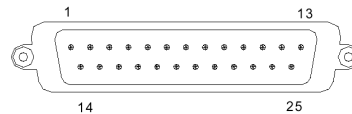

DB25M (to computer)

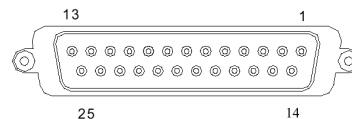

DB25F (to peripheral)

SOFTWARE COMMANDS

Logic Controls pole displays are controlled by command codes and data from the computer. The model of pole display that you have will determine which command set works with your pole. Refer to the model identification chart for further information.

Commands are transmitted to the pole display as ASCII codes. The command codes listed below are expressed in hexadecimal (base 16) numbers enclosed inside angle brackets < >, in decimal numbers enclosed in parenthesis (), and in ASCII characters enclosed in curly brackets { }. Do not include the brackets as part of the command. '^' character denotes 'Ctrl' in the keyboard. Press and hold 'Ctrl', then press the next key.

LOGIC CONTROLS COMMAND SET (PD3000/PD6000):

- 1. Vertical Scroll Mode <12>, (18), {^R}:**
Data is written into the second row and transferred to the first row when carriage return is received, leaving the second row empty.
- 2. Normal Display Mode <11>, (17), {^Q}:**
Data can be written into either row. Moves to the left most digit of the other row when line is full.
- 3. Brightness Control <04>, (04), {^D}:**
The brightness of the display can be adjusted using this command followed by a data byte <FF>, <60>, <40> or <20>.
- 4. Back Space <08>, (08), {^H}:**
The cursor position moves one digit to the left erasing the previous information.
- 5. Horizontal Tab <09>, (09), {^I}:**
The cursor position shifts one digit to the right without erasing character at original cursor position.
- 6. Line Feed <0A>, (10), {^J}:**
The cursor position moves to the same position in the other row. In vertical scroll mode, if cursor was in second row, the cursor will not move and display will scroll up.
- 7. Carriage Return <0D>, (13), {^M}:**
The cursor moves to the left most digit of the row it is in.

8. **Digit Select <10>, (16), {^P}:**
Moves the cursor to any position on the display with this command followed by a data byte of <00> to <27>, or in decimal (00) to (39).
9. **Cursor On <13>, (19), {^S}:**
Turns on the cursor.
10. **Cursor Off <14>, (20), {^T}:**
Turns off the cursor.
11. **Reset <1F>, (31), {^_}:**
All characters are erased and all settings are returned to the power-on reset conditions.
12. **Down Load Font <03><X> <F> <F> <F> <F> <F>:**
Assign a keyboard key (ASCII code <20> to <7F>) to a different style font. The “X” represents the ASCII code for the selected key. The “F’s” represent the 5 segments that will make up the special font.
13. **Message Scroll <05><X><X><X> ... <X><0D>:**
Scrolls a continuous message of up to 45 characters.

PASS-THRU COMMAND SET (PD3100, PD6100):

All software commands of the non-pass-thru model are available with following additional commands for pass-thru control. When power is turned on or after a reset command has been initiated, all text is displayed on the pole display.

1. **Data to Peripheral <01>, (01), <^A>:**
All data following this command will be sent to the peripheral until a “Data to Display” command is received.
2. **Data to Display <21><23><02>, (33)(35)(02), {!}{#}{^B}:**
All data following this command will be sent to the pole display until a “Data to Peripheral” command is received.

HARDWARE CONFIGURATION

Serial pole displays were factory configured for serial RS232C interface using the following protocol:

- 9600 Baud Rate
- 8 Data Bits
- 1 Stop Bit
- No Parity

Other optional baud rates are available with factory settings. Refer to the model identification chart for further information.

DISPLAY CHARACTER CODES

				D7	0	0	0	0	0	0	0	0	0
				D6	0	0	0	0	1	1	1	1	
				D5	0	0	1	1	0	0	1	1	
				D4	0	1	0	1	0	1	0	1	
D3	D2	D1	D0		0	1	2	3	4	5	6	7	
0	0	0	0	0		DP	SP	0	@	P	'	p	
0	0	0	1	1		DC1	!	1	A	Q	a	q	
0	0	1	0	2		DC2	"	2	B	R	b	r	
0	0	1	1	3	DL	DC3	#	3	C	S	c	s	
0	1	0	0	4	DIM	DC4	\$	4	D	T	d	t	
0	1	0	1	5	MS		%	5	E	U	e	u	
0	1	1	0	6			&	6	F	V	f	v	
0	1	1	1	7			'	7	G	W	g	w	
1	0	0	0	8	BS		(8	H	X	h	x	
1	0	0	1	9	HT)	9	I	Y	i	y	
1	0	1	0	A	LF		*	:	J	Z	j	z	
1	0	1	1	B			+	;	K	[k	{	
1	1	0	0	C	CR		,	<	L	\	l		
1	1	0	1	D			-	=	M]	m	}	
1	1	1	0	E			.	>	N	^	n	~	
1	1	1	1	F		RST	/	?	O	_	o		

GENERAL SPECIFICATIONS

	<u>PD3000</u>	<u>PD6000</u>
OPTICAL:		
Number of rows	2	2
Number of digits/row	20	20
Dot matrix	5 x 7 plus underline	5X7 plus comma
Digit height	0.20in. (5.0mm)	0.44in. (11.25mm)
Digit width	0.14in. (3.5mm)	0.28in. (7.2mm)
Character format	ASCII	ASCII
Brightness (typical)	690 cd/m ²	700 cd/m ²
Display color	Green-Blue	Green-Blue
MTBF (hours)	300,000	300,000
MECHANICAL:		
Weight	2.4 lb.	2.8 lb.
Dimensions (in inches)	(w x h x d)	(w x h x d)
Display head	7.9 x 3.4 x 1.75	11.0 x 3.25 x 1.75
Rectangular base	2.12 x 2.0 x 2.25	2.12 x 2.0 x 2.25
Base plate	4.0 x 0.09 x 8.0	4.0 x 0.09 x 8.0
Overall height (typical)	25	25
ELECTRICAL:		
Adapter input power	120VAC, 60Hz; optional 220VAC, 50Hz	
Adapter output power	6VAC, 1000mA	
ENVIRONMENTAL:		
Operating temperature	0 to +50 °C	
Storage temperature	-20 to +70 °C	
Relative Humidity	80%, non-condensing	
Vibration (10 to 55 Hz.)	4G's	
Shock	40G's	
CABLES & CONNECTORS:		
Serial		
Display cable	6-pin DIN (male)	
Interface cable	6-pin DIN (female)	
	DB9 (female); optional DB25 (female)	
	Phone jack (male)	
Power adapter	Phone jack (female)	
Parallel		
Display cable	DB25 (female)	